

Notice for TAIYO YUDEN products

Please read this notice before using the TAIYO YUDEN products.

REMINDERS

- Product information in this catalog is as of October 2014. All of the contents specified herein are subject to change without notice due to technical improvements, etc. Therefore, please check for the latest information carefully before practical application or usage of the Products.

Please note that TAIYO YUDEN CO., LTD. shall not be responsible for any defects in products or equipment incorporating such products, which are caused under the conditions other than those specified in this catalog or individual specification.

- Please contact TAIYO YUDEN CO., LTD. for further details of product specifications as the individual specification is available.
- Please conduct validation and verification of products in actual condition of mounting and operating environment before commercial shipment of the equipment.

- All electronic components or functional modules listed in this catalog are developed, designed and intended for use in general electronics equipment.(for AV, office automation, household, office supply, information service, telecommunications, (such as mobile phone or PC) etc.). Before incorporating the components or devices into any equipment in the field such as transportation,(automotive control, train control, ship control), transportation signal, disaster prevention, medical, public information network (telephone exchange, base station) etc. which may have direct influence to harm or injure a human body, please contact TAIYO YUDEN CO., LTD. for more detail in advance.

Do not incorporate the products into any equipment in fields such as aerospace, aviation, nuclear control, submarine system, military, etc. where higher safety and reliability are especially required.

In addition, even electronic components or functional modules that are used for the general electronic equipment, if the equipment or the electric circuit require high safety or reliability function or performances, a sufficient reliability evaluation check for safety shall be performed before commercial shipment and moreover, due consideration to install a protective circuit is strongly recommended at customer's design stage.

- The contents of this catalog are applicable to the products which are purchased from our sales offices or distributors (so called "TAIYO YUDEN' s official sales channel").
It is only applicable to the products purchased from any of TAIYO YUDEN' s official sales channel.

- Please note that TAIYO YUDEN CO., LTD. shall have no responsibility for any controversies or disputes that may occur in connection with a third party's intellectual property rights and other related rights arising from your usage of products in this catalog. TAIYO YUDEN CO., LTD. grants no license for such rights.

- Caution for export

Certain items in this catalog may require specific procedures for export according to "Foreign Exchange and Foreign Trade Control Law" of Japan, "U.S. Export Administration Regulations", and other applicable regulations. Should you have any question or inquiry on this matter, please contact our sales staff.

MULTILAYER CERAMIC DEVICES / DIPLEXERS / BALUNS



ORDERING CODE

REFLOW

F I △ 2 1 2 B 2 4 5 0 2 6 - T

1 Device code	2 Electrode code	3 Dimensions code [mm]	4 Special Code	5 Frequency [MHz]	6 Spec Code	7 Packaging
FI High Frequency Devices	△ With Plating △ Blank space	325 3.2×2.5 212 2.0×1.25 168 1.6×0.8 105 1.0×0.5	B Band Pass Type L Low Pass Type C Balance Type P Diplexer T Balun D Dual Type	example 2450 2400~2500 0620 470~770	01~ Individual Spec	-T Tape & Reel

EXTERNAL DIMENSIONS/STANDARD QUANTITY

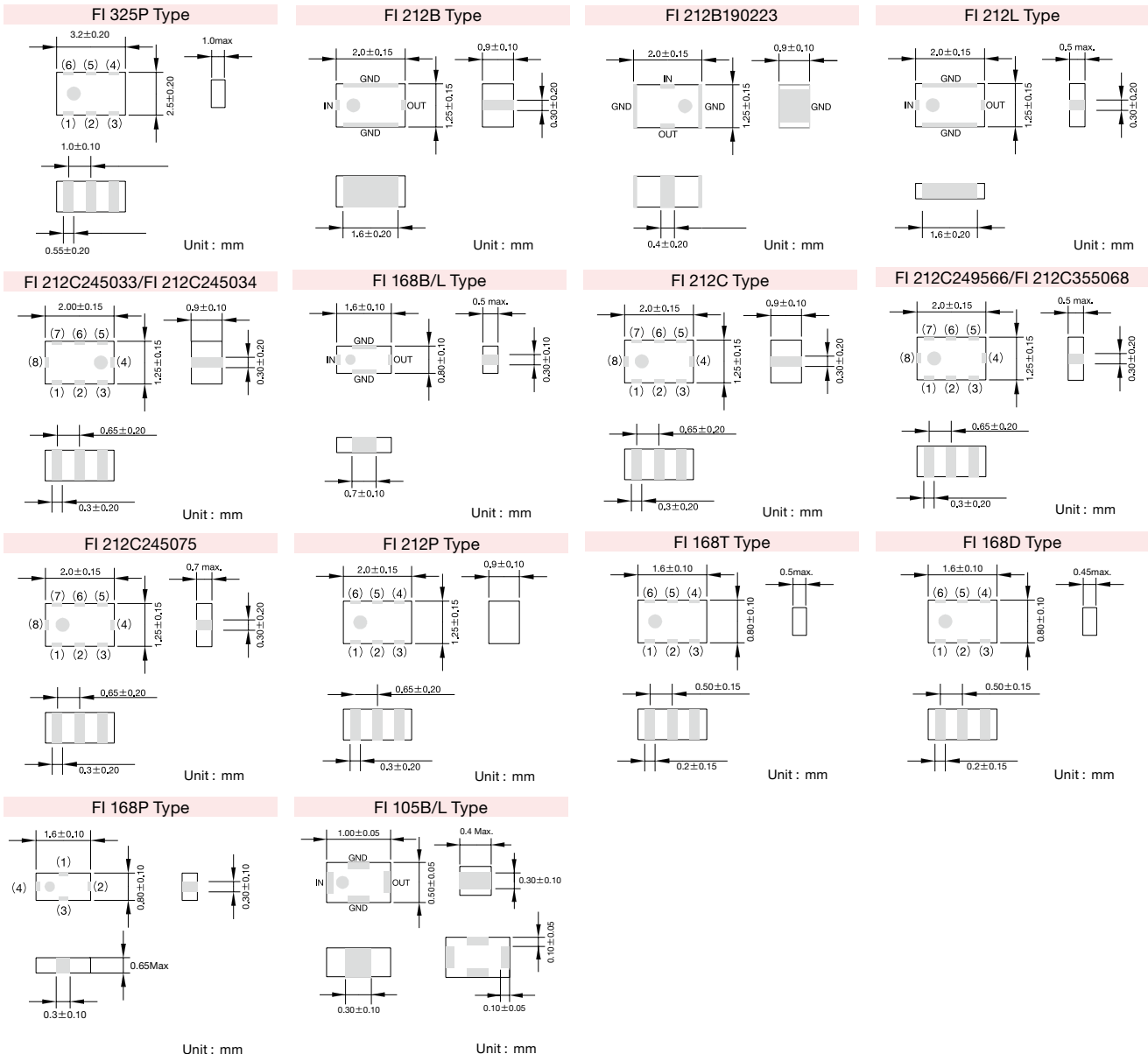

	FI 325P Type	FI 212C2450XX	FI 212C249566 FI 212C355068	FI 212P089208/ FI 212P085912	FI 212P089213/ FI 212P085909	FI 168T Type	FI 168P245010/ FI 168P245023	FI 168D087018	FI 168P 157519
(1)	GND	Balanced	Balanced	GND	GND	Unbalance	GND	High Band IN	GND
(2)	Common	GND	GND	Common Port	Common Port	GND	Low Band	GND	High Band
(3)	GND	Balanced	Balanced	GND	GND	Balanced	Common	Low Band IN	Common
(4)	High Band	GND	GND	High Band	Low Band	Balanced	High Band	Low Band OUT	Low Band
(5)	GND	Unbalance	Unbalance	GND	GND	GND	-	GND	-
(6)	Low Band	DC	NC or DC	Low Band	High Band	NC	-	High Band OUT	-
(7)	-	NC	NC	-	-	-	-	-	-
(8)	-	GND	GND	-	-	-	-	-	-

Type	Standard Quantity [pcs]
325P	2000
212B	
212L	3000~
212C	6000
212P	
168B	
168L	4000~
168T	8000
168D	
168P	
105B	10000
105L	

► This catalog contains the typical specification only due to the limitation of space. When you consider the purchase of our products, please check our specification. For details of each product (characteristics graph, reliability information, precautions for use, and so on), see our Web site (<http://www.ty-top.com/>).

PART NUMBERS

Multi-layer Device band pass Type

Applications	External dimensions	Ordering code	Notes
2.4GHz W-LAN Bluetooth	2.0×1.25×1.0 max.	FI 212B245026/FI 212B245027	
	1.6×0.8×0.5 max.	FI 168B245001	
	1.0×0.5×0.4 max.	FI 105B245024	
WiMAX	1.6×0.8×0.5 max.	FI 168B250065	
PHS	2.0×1.25×1.0 max.	FI 212B190223	

Multi-layer Device low pass Type

Applications	External dimensions	Ordering code	Notes
Digital TV	1.6×0.8×0.45 max.	FI 168L062005	Thickness 0.45 mm max.
WiMAX	1.6×0.8×0.45 max.	FI 168L2200G9	Thickness 0.45 mm max.
	1.6×0.8×0.45 max.	FI 168L259764	Thickness 0.45 mm max.
2.4GHz W-LAN	1.0×0.5×0.4 max.	FI 105L087038	Thickness 0.4 mm max.
Bluetooth	1.0×0.5×0.4 max.	FI 105L250014	Thickness 0.4 mm max.
Other	1.6×0.8×0.45 max.	FI 168D087018	Dual band LPF

Multi-layer diplexer

Applications	External dimensions	Ordering code	Notes
W-LAN	1.6×0.8×0.65 max.	FI 168P157525	
		FI 168P245010	
		FI 168P245014	
		FI 168P245023	
Cellular	2.0×1.25×1.0 max.	FI 212P082931	
		FI 212P0829G2	
		FI 212P082934	
		FI 212P082935	
		FI 212P089208	
		FI 212P089213	
		FI 212P085909	
GPS/ 2.4GHz W-LAN	1.6×0.8×0.65 max.	FI 212P085912	
		FI 168P157519	

Multi-layer Device balance Type

Applications	External dimensions	Ordering code	Notes
Bluetooth	2.0×1.25×1.0 max.	FI 212C245032	Conjugated match to CSR BC4
	2.0×1.25×1.0 max.	FI 212C245033	Conjugated match to CSR BC3
	2.0×1.25×1.0 max.	FI 212C245036	Conjugated match to CSR BC5
	2.0×1.25×0.7 max.	FI 212C245075	Conjugated match to CSR BC5FM, BC6ROM
WiMAX	2.0×1.25×0.5 max.	FI 212C249566	Thickness 0.5 mm max.
	2.0×1.25×0.5 max.	FI 212C355068	Thickness 0.5 mm max.

Multi-layer Balun

Applications	External dimensions	Ordering code	Notes
BS	1.6×0.8×0.5 max.	FI 168T155021	Thickness 0.5 mm max.

ELECTRICAL CHARACTERISTICS·TYPICAL CHARACTERISTICS

FI 212B245026

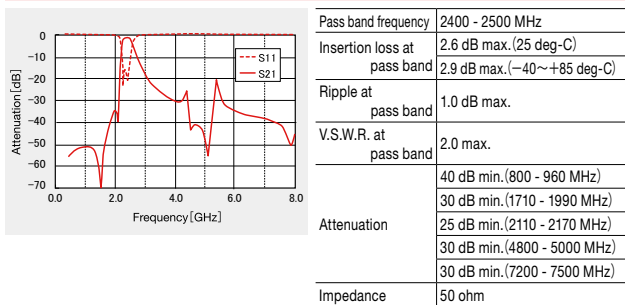

FI 105B245024

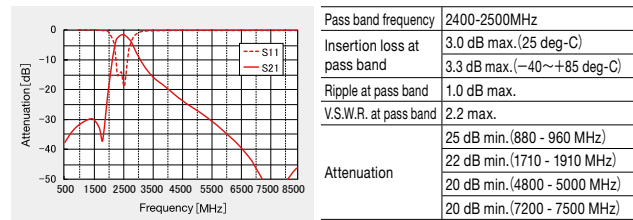

FI 212B245027

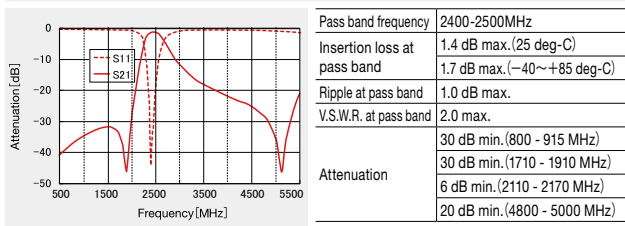

FI 168B250065

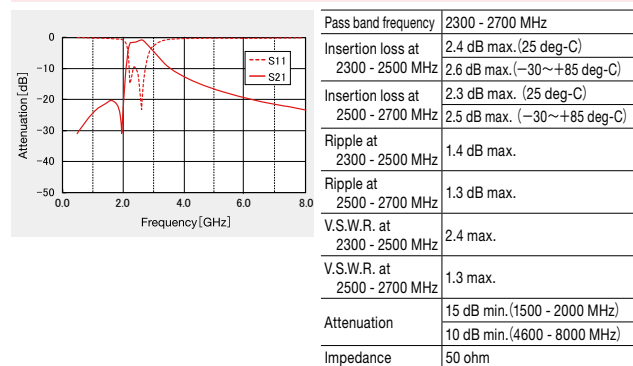

FI 168B245001

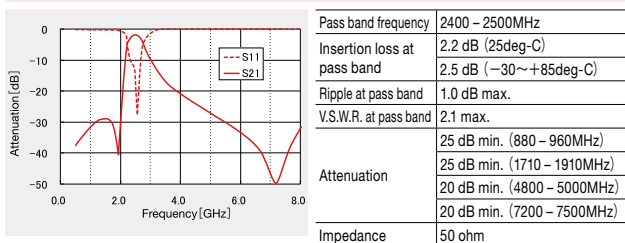

FI 212B190223

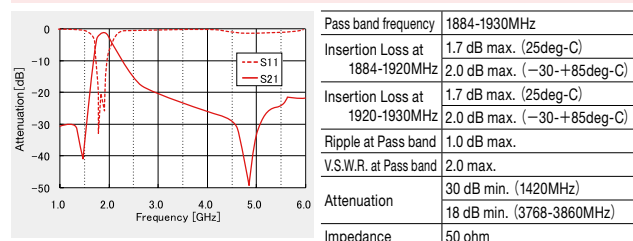

► This catalog contains the typical specification only due to the limitation of space. When you consider the purchase of our products, please check our specification. For details of each product (characteristics graph, reliability information, precautions for use, and so on), see our Web site (<http://www.ty-top.com/>).

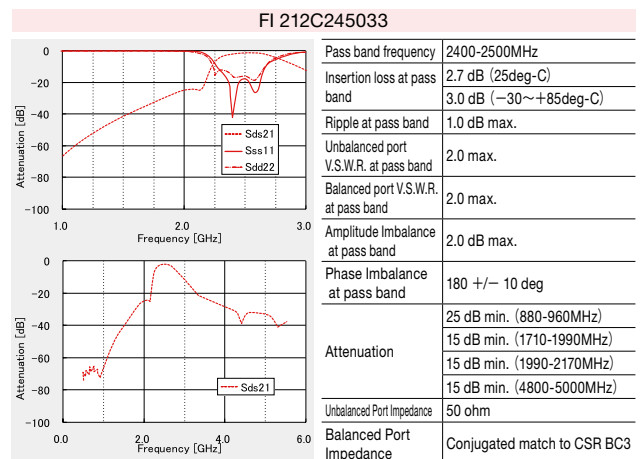
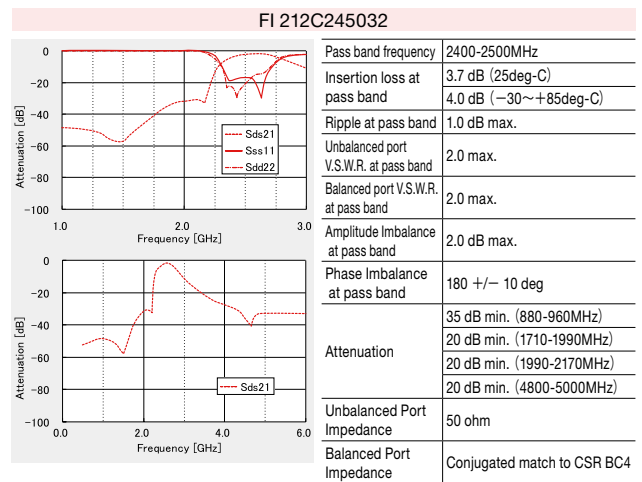
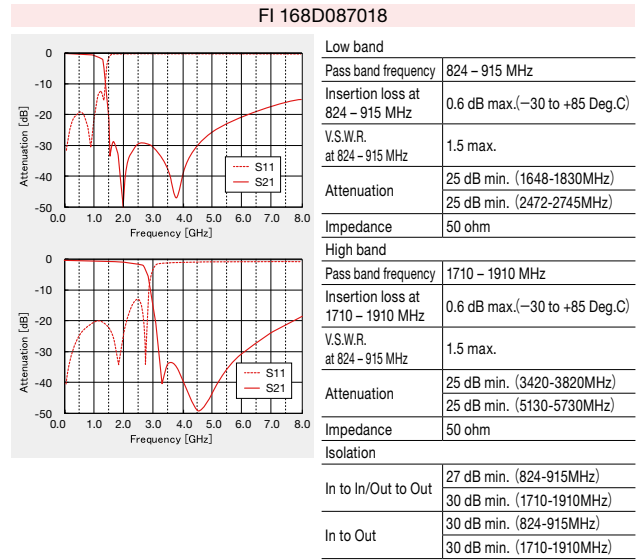
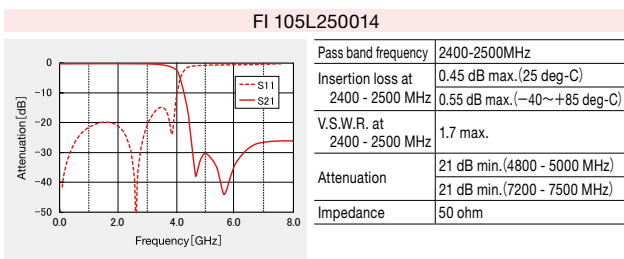
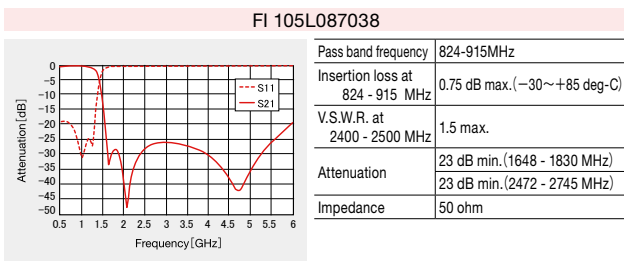
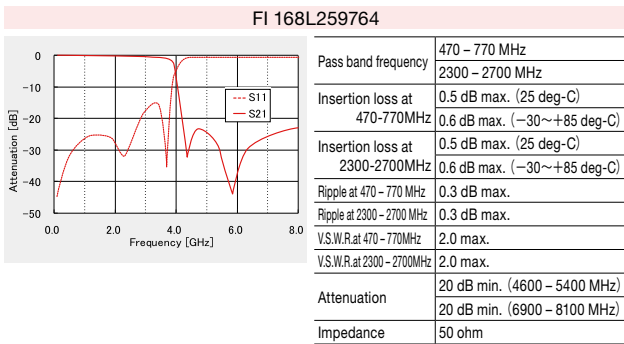
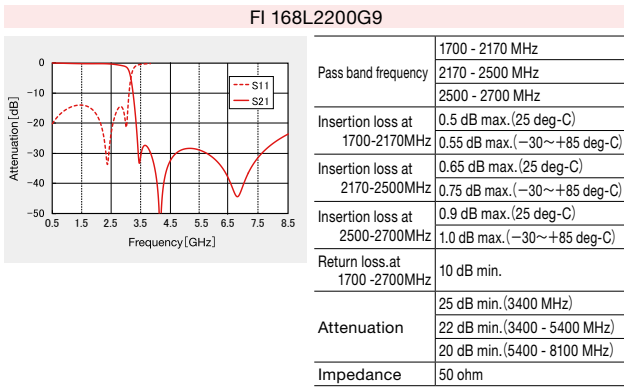
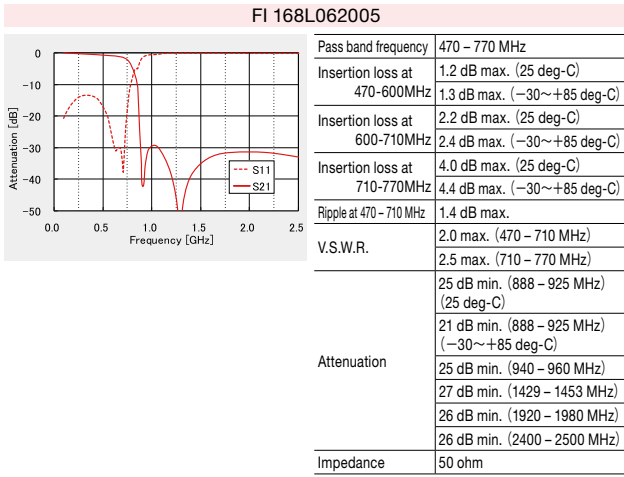

▶ This catalog contains the typical specification only due to the limitation of space. When you consider the purchase of our products, please check our specification. For details of each product (characteristics graph, reliability information, precautions for use, and so on), see our Web site (<http://www.ty-top.com/>).

FI 212C245036

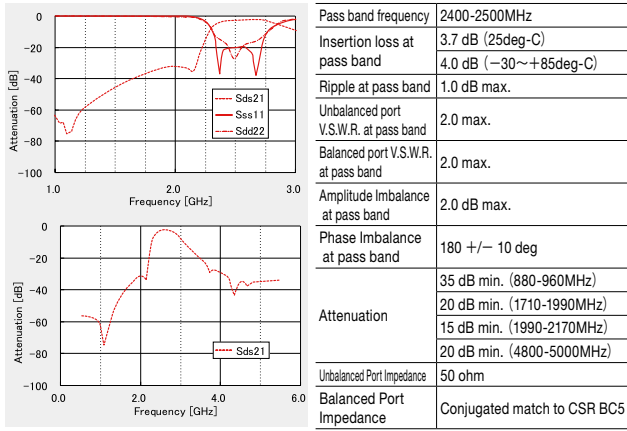

FI 212C355068

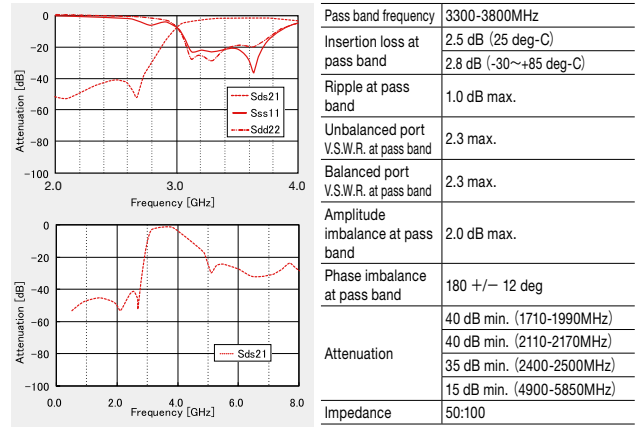

FI 212C245075

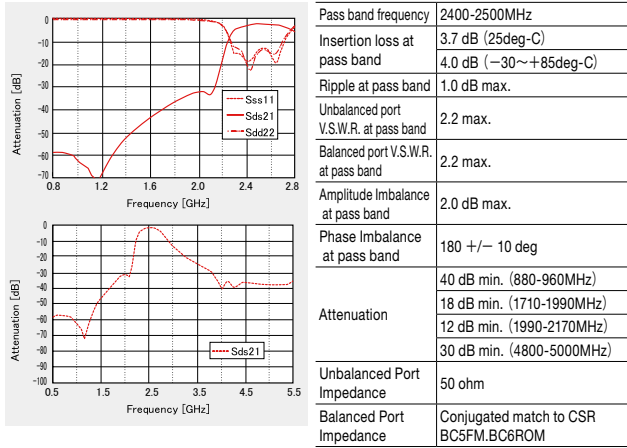

FI 168P157525

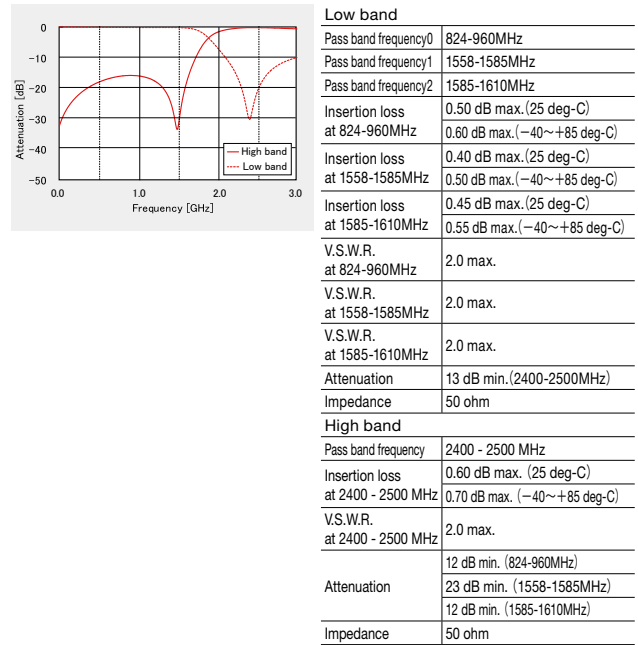

FI 212C249566

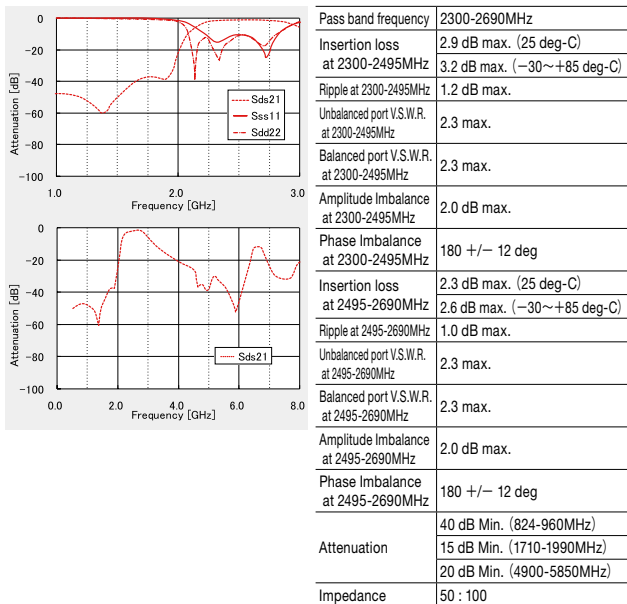

FI 168P245010

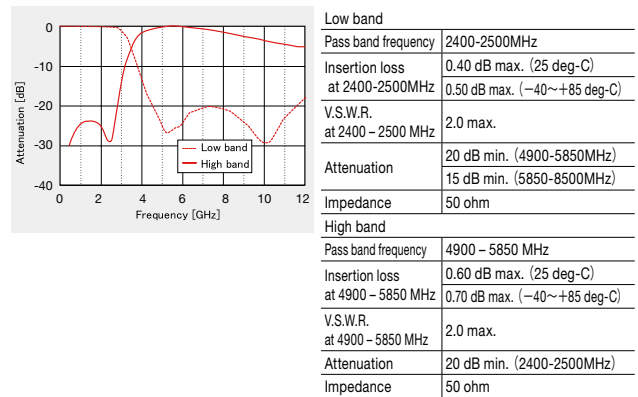

► This catalog contains the typical specification only due to the limitation of space. When you consider the purchase of our products, please check our specification. For details of each product (characteristics graph, reliability information, precautions for use, and so on), see our Web site (<http://www.ty-top.com/>).

FI 168P245014

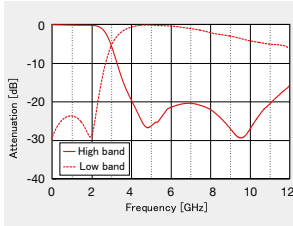

Low band	
Pass band frequency	2400-2500MHz
Insertion loss at 2400-2500MHz	0.40 dB max.(25 deg-C) 0.50 dB max.(-40~+85 deg-C)
V.S.W.R. at 2400 - 2500 MHz	2.0 max.
Attenuation	20 dB min.(4900-5850MHz) 15 dB min.(5850-8500MHz)
Impedance	50 ohm
High band	
Pass band frequency	4900 - 5850 MHz
Insertion loss at 4900 - 5850 MHz	0.60 dB max.(25 deg-C) 0.70 dB max.(-40~+85 deg-C)
V.S.W.R. at 4900 - 5850 MHz	2.0 max.
Attenuation	20 dB min.(2400-2500MHz)
Impedance	50 ohm

FI 168P245023

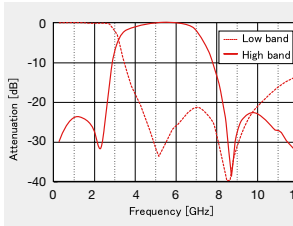

Low band	
Pass band frequency	2400-2500MHz
Insertion loss at 2400-2500MHz	0.60 dB max. (25 deg-C) 0.70 dB max. (-40~+85 deg-C)
V.S.W.R. at 2400 - 2500 MHz	2.0 max.
Attenuation	20 dB min. (4800-6000MHz) 20 dB min. (7200-7500MHz)
Impedance	50 ohm
High band	
Pass band frequency	4900 - 5950 MHz
Insertion loss at 4900 - 5850 MHz	0.80 dB max. (25 deg-C) 0.95 dB max. (-40~+85 deg-C)
V.S.W.R. at 4900 - 5850 MHz	2.0 max.
Attenuation	20 dB min. (1800-2500MHz) 20 dB min. (9800-11900MHz) *Referece
Impedance	50 ohm

FI 212P082931

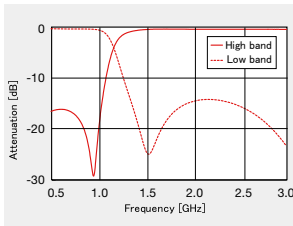

Low band	
Pass band frequency1	698 - 894 MHz
Pass band frequency2	880 - 960 MHz
Insertion loss at 698 - 894 MHz	0.50 dB max.(+25 Deg.C) 0.60 dB max.(-40 to +85 Deg.C)
Insertion loss at 880 - 960 MHz	0.70 dB max.(+25 Deg.C) 0.80 dB max.(-40 to +85 Deg.C)
V.S.W.R. at 698 - 894 MHz	2.0 max.
V.S.W.R. at 880 - 960 MHz	2.0 max.
Attenuation	13dB min.(1420-2690MHz)
Impedance	50 ohm
High band	
Pass band frequency1	1420 - 1520 MHz
Pass band frequency2	1560 - 1610 MHz
Pass band frequency3	1710 - 2170 MHz
Pass band frequency4	2300 - 2690 MHz
Insertion loss at 1420 - 1520 MHz	0.70 dB max. (+25 Deg.C) 0.80 dB max. (-40 to +85 Deg.C)
Insertion loss at 1560 - 1610 MHz	0.50 dB max. (+25 Deg.C) 0.60 dB max. (-40 to +85 Deg.C)
Insertion loss at 1710 - 2170 MHz	0.50 dB max. (+25 Deg.C) 0.60 dB max. (-40 to +85 Deg.C)
Insertion loss at 2300 - 2690 MHz	0.50 dB max. (+25 Deg.C) 0.60 dB max. (-40 to +85 Deg.C)
V.S.W.R. at 1420 - 2690 MHz	2.0 max.
Attenuation	13dB min. (698-960MHz)
Impedance	50 ohm

FI 212P0829G2

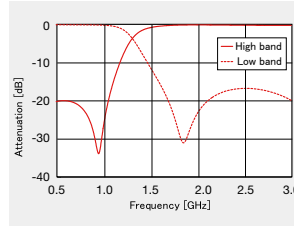

Low band	
Pass band frequency	698 - 960 MHz
Insertion loss at 698 - 960 MHz	0.45 dB max.(+25 Deg.C) 0.32 dB max.(-40 to +85 Deg.C)
V.S.W.R. at 698 - 960 MHz	2.0 max.
Attenuation	13dB min.(1710-2690MHz)
Impedance	50 ohm
High band	
Pass band frequency	1710 - 2690 MHz
Insertion loss at 1710 - 2690 MHz	0.45 dB max.(+25 Deg.C) 0.55 dB max.(-40 to +85 Deg.C)
V.S.W.R. at 698 - 960 MHz	2.0 max.
Attenuation	19dB min.(698-960MHz)
Impedance	50 ohm

FI 212P082934

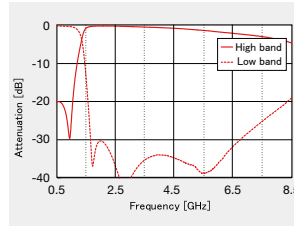

Low band	
Pass band frequency	698 - 960 MHz
Insertion loss at 698 - 960 MHz	0.50 dB max.(-40 to +85 Deg.C)
V.S.W.R. at 698 - 960 MHz	1.4 max.
Attenuation	15dB min.(1554-1580MHz) 25dB min.(1710-2110MHz) 25dB min.(2110-2155MHz) 25dB min.(2155-2690MHz) 12dB min.(2155-7830MHz)
Impedance	50 ohm
High band	
Pass band frequency1	1710 - 2170 MHz
Pass band frequency2	2500 - 2690 MHz
Insertion loss at 1710 - 2170 MHz	0.50 dB max.(-40 to +85 Deg.C)
Insertion loss at 2500 - 2690 MHz	0.55 dB max.(-40 to +85 Deg.C)
V.S.W.R. at 1710 - 2170 MHz	1.4 max.
V.S.W.R. at 2500 - 2690 MHz	1.8 max.
Attenuation	17dB min.(0.3-960MHz)
Impedance	50 ohm

FI 212P082935

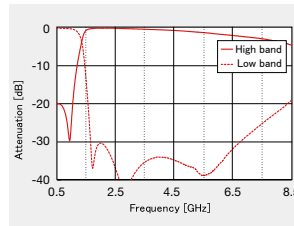

Low band	
Pass band frequency	698 - 960 MHz
Insertion loss at 698 - 960 MHz	0.50 dB max.(-40 to +85 Deg.C)
V.S.W.R. at 698 - 960 MHz	1.4 max.
Attenuation	15dB min.(1554-1580MHz) 25dB min.(1710-2110MHz) 25dB min.(2110-2155MHz) 25dB min.(2155-2690MHz) 12dB min.(2155-7830MHz)
Impedance	50 ohm
High band	
Pass band frequency1	1710 - 2170 MHz
Pass band frequency2	2500 - 2690 MHz
Insertion loss at 1710 - 2170 MHz	0.50 dB max.(-40 to +85 Deg.C)
Insertion loss at 2500 - 2690 MHz	0.55 dB max.(-40 to +85 Deg.C)
V.S.W.R. at 1710 - 2170 MHz	1.4 max.
V.S.W.R. at 2500 - 2690 MHz	1.8 max.
Attenuation	17dB min.(0.3-960MHz)
Impedance	50 ohm

► This catalog contains the typical specification only due to the limitation of space. When you consider the purchase of our products, please check our specification. For details of each product (characteristics graph, reliability information, precautions for use, and so on), see our Web site (<http://www.ty-top.com/>).

FI 212P089208

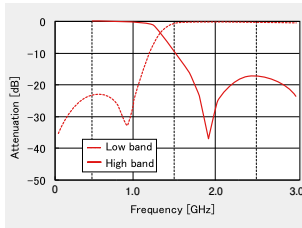

Low band	
Pass band frequency	698 – 960 MHz
Insertion loss at 698 – 960 MHz	0.27 dB max. (+25 Deg.C) 0.32 dB max. (-40 to +85 Deg.C)
V.S.W.R. at 698 – 960 MHz	2.0 max.
Attenuation	13dB min. (1710-2170MHz)
Impedance	50 ohm
High band	
Pass band frequency	1710 – 2170 MHz
Insertion loss at 1710 – 2170 MHz	0.45 dB max. (+25 Deg.C) 0.55 dB max. (-40 to +85 Deg.C)
V.S.W.R. at 698 – 960 MHz	2.0 max.
Attenuation	19dB min. (698-960MHz)
Impedance	50 ohm

FI 212P085912

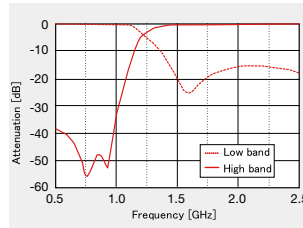

Low band	
Pass band frequency	698–960 MHz
Insertion loss at 698 – 960 MHz	0.70 dB max. (+25 deg.-C) 0.75 dB max. (-30~+85 deg.-C)
V.S.W.R. at 698 – 960 MHz	1.6 max.
Attenuation	19dB min. (1558–1570MHz) 20dB min. (1570–1580MHz) 19dB min. (1580–1610MHz)
Impedance	50 ohm
High band	
Pass band frequency 1	1558–1570MHz
Pass band frequency 2	1570–1580MHz
Pass band frequency 3	1580–1610MHz
Insertion loss at 1558 – 1570 MHz	0.75 dB max. (+25 deg.-C) 0.85 dB max. (-30~+85 deg.-C)
Insertion loss at 1570 – 1580 MHz	0.70 dB max. (+25 deg.-C) 0.80 dB max. (-30~+85 deg.-C)
Insertion loss at 1580 – 1610 MHz	0.70 dB max. (+25 deg.-C) 0.80 dB max. (-30~+85 deg.-C)
V.S.W.R. at 1558 – 1570 MHz	1.6 max.
V.S.W.R. at 1570 – 1580 MHz	1.6 max.
V.S.W.R. at 1580 – 1610 MHz	1.6 max.
Attenuation	35dB min. (698–824MHz) 42dB min. (824–894MHz) 25dB min. (894–960MHz)
Impedance	50 ohm

FI 212P089213

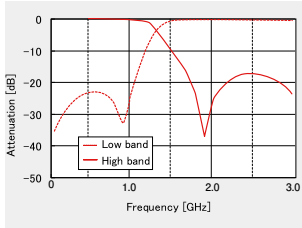

Low band	
Pass band frequency	698 – 960 MHz
Insertion loss at 698 – 960 MHz	0.27 dB max. (+25 Deg.C) 0.32 dB max. (-40 to +85 Deg.C)
V.S.W.R. at 698 – 960 MHz	2.0 max.
Attenuation	13dB min. (1710-2170MHz)
Impedance	50 ohm
High band	
Pass band frequency	1710 – 2170 MHz
Insertion loss at 1710 – 2170 MHz	0.45 dB max. (+25 Deg.C) 0.55 dB max. (-40 to +85 Deg.C)
V.S.W.R. at 698 – 960 MHz	2.0 max.
Attenuation	19dB min. (698-960MHz)
Impedance	50 ohm

FI 168P157519

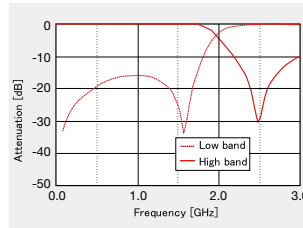

Low band	
Pass band frequency 0	824–960MHz
Pass band frequency 1	1558–1585MHz
Pass band frequency 2	1585–1610MHz
Insertion loss at 824 – 960 MHz	0.50 dB max. (+25 deg.-C) 0.60 dB max. (-40~+85 deg.-C)
Insertion loss at 1558 – 1585 MHz	0.40 dB max. (+25 deg.-C) 0.50 dB max. (-40~+85 deg.-C)
Insertion loss at 1585 – 1610 MHz	0.45 dB max. (+25 deg.-C) 0.55 dB max. (-40~+85 deg.-C)
V.S.W.R. at 824 – 960 MHz	2.0 max.
V.S.W.R. at 1558 – 1585 MHz	2.0 max.
V.S.W.R. at 1585 – 1610 MHz	2.0 max.
Attenuation	13dB min. (2400-2500MHz)
Impedance	50 ohm
High Band	
Pass band frequency	2400 – 2500 MHz
Insertion loss at 2400 – 2500 MHz	0.60 dB max. (+25 deg.-C) 0.70 dB max. (-40~+85 deg.-C)
V.S.W.R. at 2400 – 2500 MHz	2.0 max.
Attenuation	12dB min. (824–960MHz) 23dB min. (1558–1585MHz) 20dB min. (1585–1610MHz)
Impedance	50 ohm

FI 212P085909

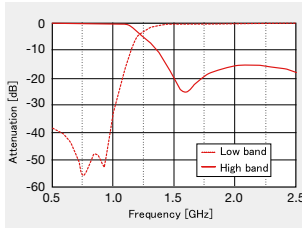

Low band	
Pass band frequency	698–960 MHz
Insertion loss at 698 – 960 MHz	0.70 dB max. (+25 deg.-C) 0.75 dB max. (-30~+85 deg.-C)
V.S.W.R. at 698 – 960 MHz	1.6 max.
Attenuation	19dB min. (1558–1570MHz) 20dB min. (1570–1580MHz) 19dB min. (1580–1610MHz)
Impedance	50 ohm
High band	
Pass band frequency 1	1558–1570MHz
Pass band frequency 2	1570–1580MHz
Pass band frequency 3	1580–1610MHz
Insertion loss at 1558 – 1570 MHz	0.75 dB max. (+25 deg.-C) 0.85 dB max. (-30~+85 deg.-C)
Insertion loss at 1570 – 1580 MHz	0.70 dB max. (+25 deg.-C) 0.80 dB max. (-30~+85 deg.-C)
Insertion loss at 1580 – 1610 MHz	0.70 dB max. (+25 deg.-C) 0.80 dB max. (-30~+85 deg.-C)
V.S.W.R. at 1558 – 1570 MHz	1.6 max.
V.S.W.R. at 1570 – 1580 MHz	1.6 max.
V.S.W.R. at 1580 – 1610 MHz	1.6 max.
Attenuation	35dB min. (698–824MHz) 42dB min. (824–894MHz) 25dB min. (894–960MHz)
Impedance	50 ohm

▶ This catalog contains the typical specification only due to the limitation of space. When you consider the purchase of our products, please check our specification. For details of each product (characteristics graph, reliability information, precautions for use, and so on), see our Web site (<http://www.ty-top.com/>).

FI 168T155021

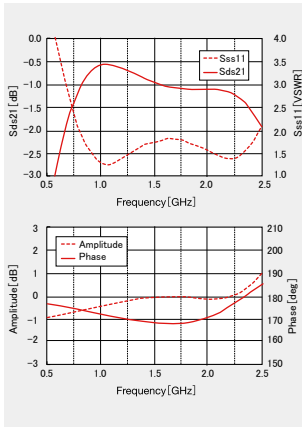

Pass band frequency	900-2200MHz
Insertion loss at pass band	2.0 dB max. (25 deg-C)
V.S.W.R. at pass band	2.3 dB max. (-30~+85 deg-C)
Phase balance at pass band	180 +/- 20 deg
Amplitude imbalance at pass band	+/-2 dB max.
Impedance	50 : 75

▶ This catalog contains the typical specification only due to the limitation of space. When you consider the purchase of our products, please check our specification. For details of each product (characteristics graph, reliability information, precautions for use, and so on), see our Web site (<http://www.ty-top.com/>) .

MULTILAYER CERAMIC DEVICES (FILTERS / DIPLEXERS / BALUNS)

PACKAGING

① Minimum Quantity

Type	Embossed Tape [pcs]
325P	2000
212B	3000
212L	
212C	
212P	
168B	4000
168L	
168T	
168D	
168P	
105B	10000
105L	

② Tape Material

● Embossed Tape

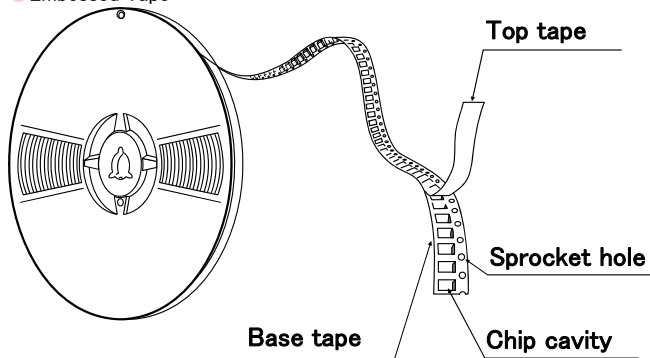

● Card Board Carrier Tape

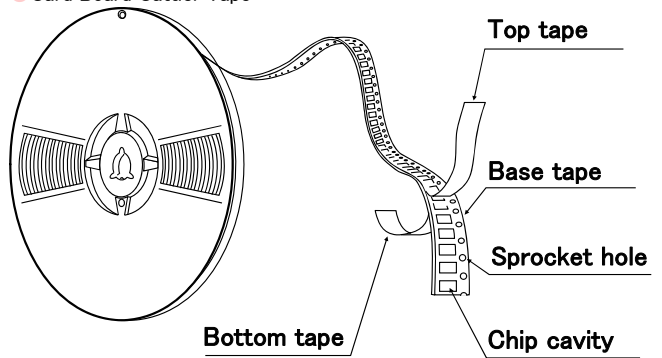

Chip Filled

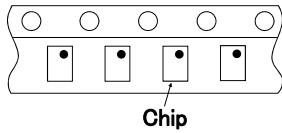

● Taped package

Type (EIA)	Thickness mm (inch)	Standard Quantity [pcs]
325P	0.90 typ.(0.035)	2000
212B	0.90 typ.(0.035)	3000
212L	0.45 typ.(0.018)	
212C	0.90 typ.(0.035)	
212P	0.90 typ.(0.035)	
212C-0.5	0.45 typ.(0.018)	
212C-0.7	0.60 typ.(0.024)	
168B	0.45 typ.(0.018)	4000
168L	0.45 typ.(0.018)	
168T	0.45 typ.(0.018)	
168D	0.45 typ.(0.018)	
168P	0.60 typ.(0.024)	
105B	0.30 typ.(0.0118)	10000
105L	0.30 typ.(0.0118)	

▶ This catalog contains the typical specification only due to the limitation of space. When you consider the purchase of our products, please check our specification. For details of each product (characteristics graph, reliability information, precautions for use, and so on), see our Web site (<http://www.ty-top.com/>).

③ Taping Dimensions

● Embossed tape 0.315 inches wide
(325P Type, 212B Type, 212C Type, 212C-0.7 Type, 212P Type)

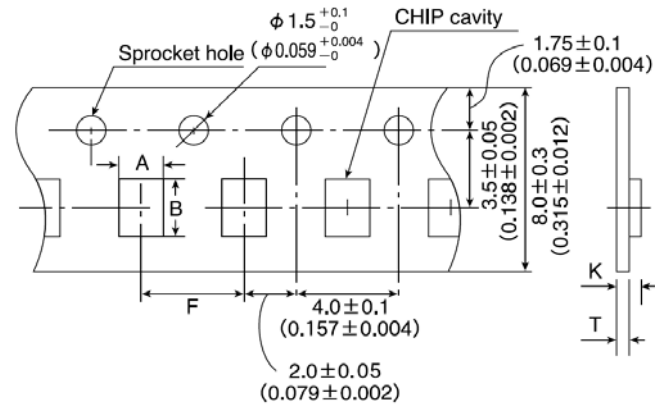

Unit: mm (inch)

Type (EIA)	Chip cavity		Insertion Pitch	Tape Thickness max.	
	A	B		K	T
325P	2.75 ± 0.2 (0.108 ± 0.008)	3.55 ± 0.2 (0.14 ± 0.008)	4.0 ± 0.1 (0.157 ± 0.004)	1.35 (0.053)	0.3 (0.012)
212B	1.55 ± 0.2 (0.061 ± 0.008)	2.3 ± 0.2 (0.091 ± 0.008)	4.0 ± 0.1 (0.157 ± 0.004)	1.6 (0.063)	0.3 (0.012)
212C	1.55 ± 0.2 (0.061 ± 0.008)	2.3 ± 0.2 (0.091 ± 0.008)	4.0 ± 0.1 (0.157 ± 0.004)	1.6 (0.063)	0.3 (0.012)
212C-0.7	1.55 ± 0.2 (0.061 ± 0.008)	2.3 ± 0.2 (0.091 ± 0.008)	4.0 ± 0.1 (0.157 ± 0.004)	1.3 (0.051)	0.3 (0.012)
212P	1.55 ± 0.2 (0.061 ± 0.008)	2.3 ± 0.2 (0.091 ± 0.008)	4.0 ± 0.1 (0.157 ± 0.004)	1.6 (0.063)	0.3 (0.012)

Unit: mm (inch)

● Paper tape 0.315 inches wide
(212L Type, 212C-0.5 Type, 168B Type, 168L Type, 168P Type, 168T Type, 168D Type, 105B Type, 105L Type)

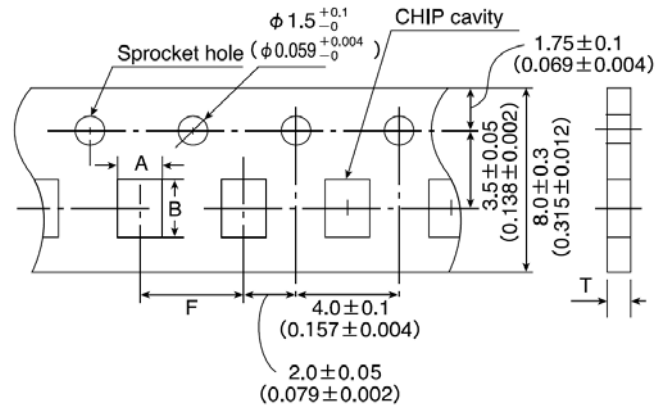

Unit: mm (inch)

Type (EIA)	Chip cavity		Insertion Pitch	Tape Thickness max.
	A	B		
212L	1.55 ± 0.2 (0.061 ± 0.008)	2.3 ± 0.2 (0.091 ± 0.008)	4.0 ± 0.1 (0.157 ± 0.004)	0.65 (0.026)
212C-0.5	1.55 ± 0.2 (0.061 ± 0.008)	2.3 ± 0.2 (0.091 ± 0.008)	4.0 ± 0.1 (0.157 ± 0.004)	0.3 (0.012)
168B	1.00 ± 0.05 (0.039 ± 0.002)	1.80 ± 0.05 (0.071 ± 0.002)	4.0 ± 0.1 (0.157 ± 0.004)	0.55 (0.022)
168L	1.00 ± 0.05 (0.039 ± 0.002)	1.80 ± 0.05 (0.071 ± 0.002)	4.0 ± 0.1 (0.157 ± 0.004)	0.55 (0.022)
168T	1.00 ± 0.05 (0.039 ± 0.002)	1.80 ± 0.05 (0.071 ± 0.002)	4.0 ± 0.1 (0.157 ± 0.004)	0.55 (0.022)
168D	1.00 ± 0.05 (0.039 ± 0.002)	1.80 ± 0.05 (0.071 ± 0.002)	4.0 ± 0.1 (0.157 ± 0.004)	0.55 (0.022)
168P	0.95 ± 0.05 (0.037 ± 0.002)	1.80 ± 0.05 (0.071 ± 0.002)	4.0 ± 0.1 (0.157 ± 0.004)	0.80 (0.031)
105B	0.62 ± 0.03 (0.024 ± 0.001)	1.12 ± 0.03 (0.044 ± 0.001)	2.0 ± 0.05 (0.079 ± 0.002)	0.45 (0.018)
105L	0.62 ± 0.03 (0.024 ± 0.001)	1.12 ± 0.03 (0.044 ± 0.001)	2.0 ± 0.05 (0.079 ± 0.002)	0.45 (0.018)

Unit: mm (inch)

▶ This catalog contains the typical specification only due to the limitation of space. When you consider the purchase of our products, please check our specification. For details of each product (characteristics graph, reliability information, precautions for use, and so on), see our Web site (<http://www.ty-top.com/>).

④ Leader and Blank Portion

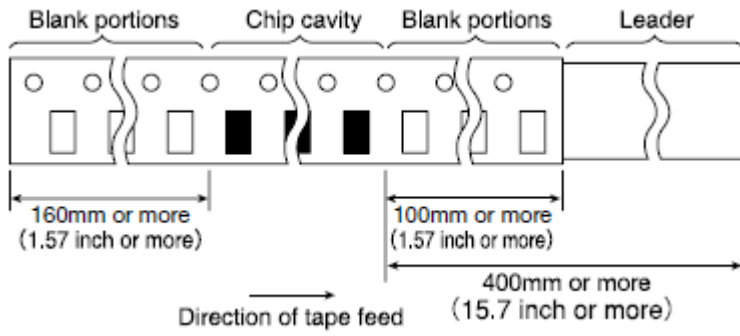

⑤ Reel size

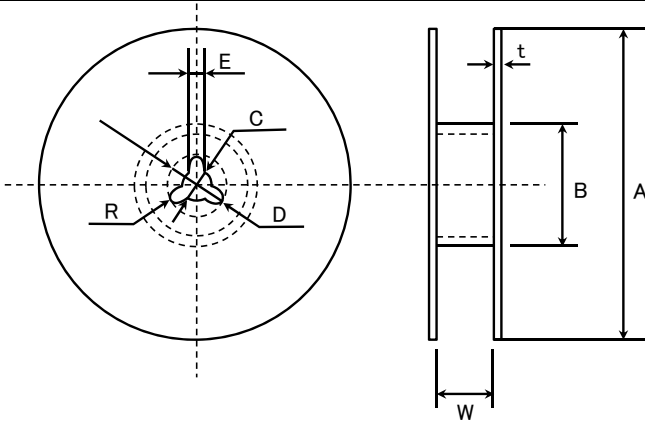

A	B	C	D	E	R
$\phi 178 \pm 2.0$ ($\phi 7.01 \pm 0.079$)	$\phi 50 \text{ min.}$ ($\phi 1.97 \text{ min.}$)	$\phi 13.0 \pm 0.2$ ($\phi 0.512 \pm 0.008$)	$\phi 21.0 \pm 0.8$ ($\phi 0.827 \pm 0.031$)	2.0 ± 0.5 (0.079 ± 0.020)	1.0
	t	W			
8mm width tape (0.315 inches width)	2.5max. (0.098max.)	10 ± 1.5 (0.394 ± 0.059)			
12mm width tape (0.472 inches width)	2.5max. (0.098max.)	14 ± 1.5 (0.551 ± 0.059)			

Unit: mm (inch)

⑥ Top Tape Strength

The top tape requires a peel-off force of 0.1~0.7N in the direction of the arrow as illustrated below.

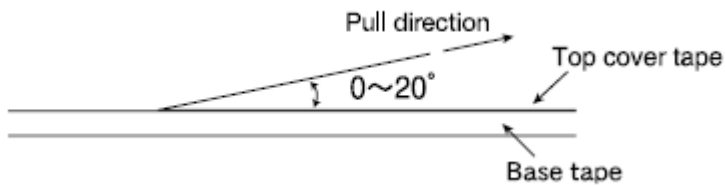

MULTILAYER CERAMIC DEVICES (FILTERS / DIPLEXERS / BALUNS)

RELIABILITY DATA

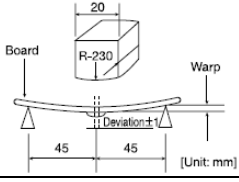
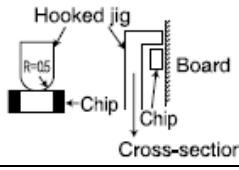
1. Operating Temperature Range	
Specified Value	-30~+85°C
2. Storage Temperature Range	
Specified Value	-30~+85°C
Test Methods and Remarks	※Note : -20 to +40°C in taped packaging
3. Resistance to Flexure of Substrate	
Specified Value	No mechanical damage.
Test Methods and Remarks	<p>Warp : 2mm Testing board : Glass epoxy-resin substrate Thickness : 0.8mm</p> 
4. Adhesion of Electrode	
Specified Value	Characteristics : shall satisfy the electrical characteristics. Appearance : No significant abnormality.
Test Methods and Remarks	<p>Applied force : 5N Duration : 10 sec.</p> 
5. Solderability	
Specified Value	75% or more of immersed surface of terminal electrode shall be covered with fresh solder.
Test Methods and Remarks	<p>Solder temperature : 230±5°C Duration : 4±1 sec Preconditioning : Immersion into flux. Immersion and Removal speed : 25mm/sec.</p>
6. Resistance to Solder Heat	
Specified Value	Characteristics : shall satisfy the electrical characteristics. Appearance : No significant abnormality.
Test Methods and Remarks	<p>Preheating : 150°C for 2 min. Solder temperature : 260±5°C Duration : 5±0.5 sec. Preconditioning : Immersion into flux. Immersion and Removal speed : 25mm/sec. Recovery : 2 to 3hrs of recovery under the standard condition after the removal from test chamber.</p>

▶ This catalog contains the typical specification only due to the limitation of space. When you consider the purchase of our products, please check our specification. For details of each product (characteristics graph, reliability information, precautions for use, and so on), see our Web site (<http://www.ty-top.com/>).

7. Thermal Shock																
Specified Value	Characteristics : shall satisfy the electrical characteristics. Appearance : No significant abnormality.															
Test Methods and Remarks	According to JIS C 0025.															
	Conditions for 1 cycle															
	<table border="1"> <thead> <tr> <th>Step</th> <th>Temperature (°C)</th> <th>Duration (min)</th> </tr> </thead> <tbody> <tr> <td>1</td> <td>-40±3</td> <td>30±3</td> </tr> <tr> <td>2</td> <td>Room Temperature</td> <td>Within 3</td> </tr> <tr> <td>3</td> <td>85±2</td> <td>30±3</td> </tr> <tr> <td>4</td> <td>Room Temperature</td> <td>Within 3</td> </tr> </tbody> </table>	Step	Temperature (°C)	Duration (min)	1	-40±3	30±3	2	Room Temperature	Within 3	3	85±2	30±3	4	Room Temperature	Within 3
	Step	Temperature (°C)	Duration (min)													
	1	-40±3	30±3													
2	Room Temperature	Within 3														
3	85±2	30±3														
4	Room Temperature	Within 3														
Number of cycles : 100																
Mounting method : Soldering onto PC board. Recovery : 2 to 3hrs of recovery under the standard condition after the removal from test chamber.																

8. Humidity (steady state)	
Specified Value	Characteristics : shall satisfy the electrical characteristics. Appearance : No significant abnormality.
Test Methods and Remarks	Temperature : +40±2°C Humidity : 90~95%RH Duration : 96hrs Recovery : 2 to 3hrs of recovery under the standard condition after the removal from test chamber.

9. High temperature life test	
Specified Value	Characteristics : shall satisfy the electrical characteristics. Appearance : No significant abnormality.
Test Methods and Remarks	Temperature : +85±2°C Duration : 96hrs Recovery : 2 to 3hrs of recovery under the standard condition after the removal from test chamber.

10. Low temperature life test	
Specified Value	Characteristics : shall satisfy the electrical characteristics. Appearance : No significant abnormality.
Test Methods and Remarks	Temperature : -40±2°C Duration : 96hrs Recovery : 2 to 3hrs of recovery under the standard condition after the removal from test chamber.

Note on standard condition:

“standard condition” referred to herein is defined as follows :
5 to 35°C of temperature, 45 to 85% relative humidity and 86 to 106kPa of air pressure.

When there are questions concerning measurement result :

In order to provide correlation data, the test shall be conducted under condition of 20±2°C of temperature, 60 to 70% relative humidity and 86 to 106kPa of air pressure.

Unless otherwise specified, all the tests are conducted under the “standard condition”.

MULTILAYER CERAMIC DEVICES (FILTERS / DIPLEXERS / BALUNS)

PRECAUTIONS

1. PCB Design

◆ Land pattern design

Land pattern dimension examples

Technical considerations

<p>FI325P Type</p> <p>Unit: mm</p>	<p>FI212B Type</p> <p>Unit: mm</p>	<p>FI212B245025 FI212B190223</p> <p>Unit: mm</p>	<p>FI212L Type</p> <p>Unit: mm</p>
<p>FI168T/D Type</p> <p>Unit: mm</p>	<p>FI168B/L Type</p> <p>Unit: mm</p>	<p>FI168P Type</p> <p>Unit: mm</p>	<p>FI212C Type</p> <p>Unit: mm</p>
<p>FI212P Type</p> <p>Unit: mm</p>	<p>FI212 P3960A4</p> <p>Unit: mm</p>	<p>FI105B/L Type</p> <p>Unit: mm</p>	

2. Soldering

◆ Conditions for Reflow soldering (for reference)

【Reflow Profile】

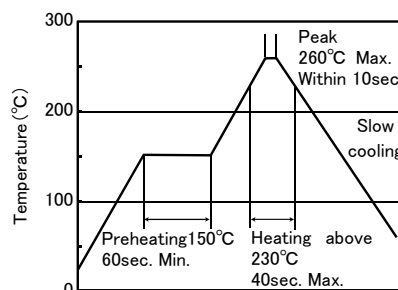
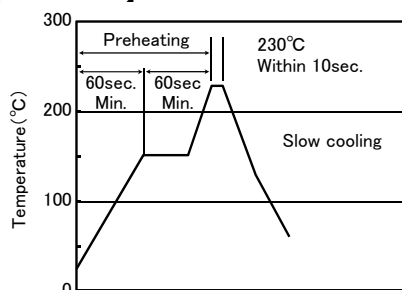

- ※ Components should be preheated to within 100 to 130°C from soldering temperature.
- ※ Assured to be reflow soldering for 2 times.

Note : The above profiles are the maximum allowable soldering condition, therefore these profiles are not always recommended.

Technical considerations

3. Storage conditions

Precautions	<p>◆Storage</p> <p>1. To maintain the solderability of terminal electrodes and to keep the packaging material in good condition, care must be taken to control temperature and humidity in the storage area. Humidity should especially be kept as low as possible.</p> <ul style="list-style-type: none">• Recommended conditions Ambient temperature : $-20\sim+40^{\circ}\text{C}$ Humidity : Below 70%RH The ambient temperature must be kept below 30°C. Even under ideal storage conditions, the solderability of electrodes decreases gradually, so filters should be mounted within 6 months from the time of delivery.• The packaging material should be kept where no chlorine or sulfur exists in the air.
Technical considerations	<p>◆Storage</p> <p>1. If the parts are stocked in a high temperature and humidity environment, problems such as reduced solderability caused by oxidation of terminal electrodes and deterioration of taping/ packaging materials may take place. For this reason, components should be used within 6 months from the time of delivery. If exceeding the above period, please check the solderability before using the filter.</p>

- Please contact of our offices for further details of specifications.
All of the standard values listed here are subject to change without notice.
Therefore, please check the specifications carefully before use.